

POWER

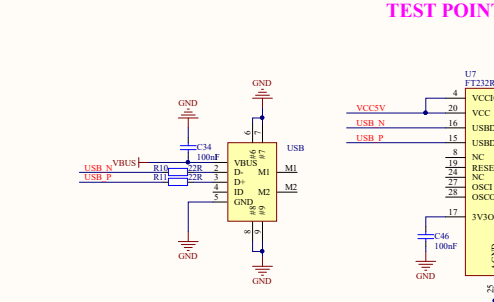

TEST POINT

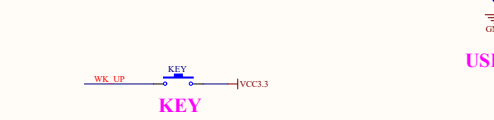

KEY

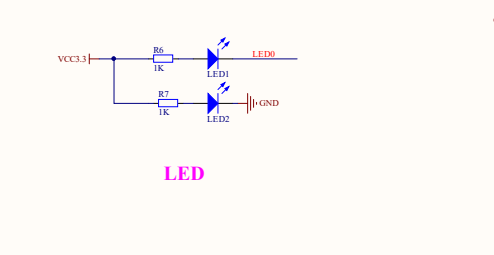

LED

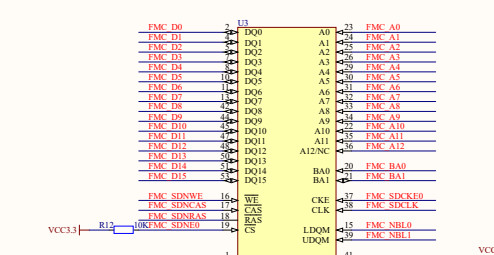

RGB LCD

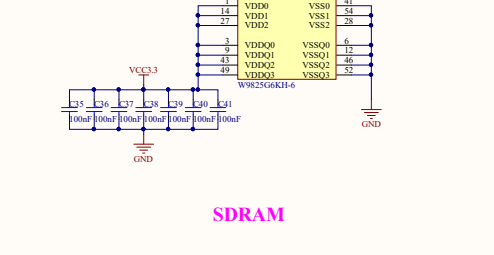

SDRAM

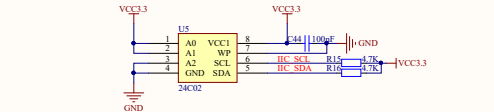

EEPROM

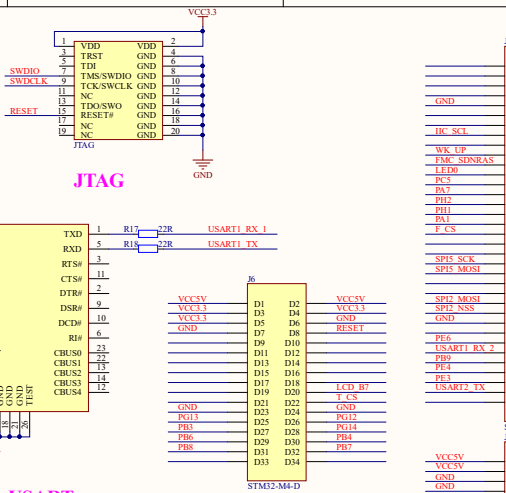

JTAG

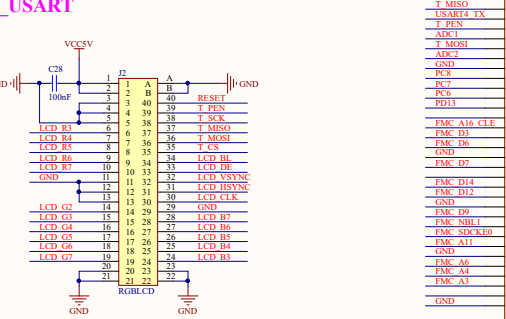

USB_USART

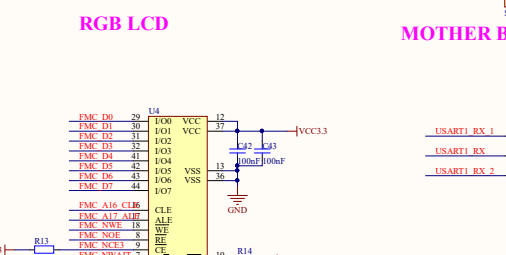

MOTHER BOARD CON

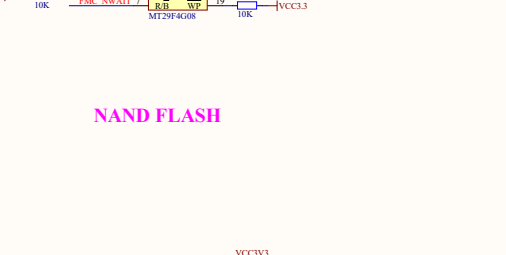

NAND FLASH

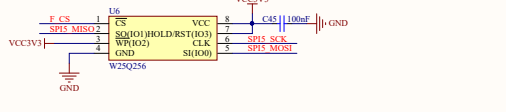

SPI FLASH

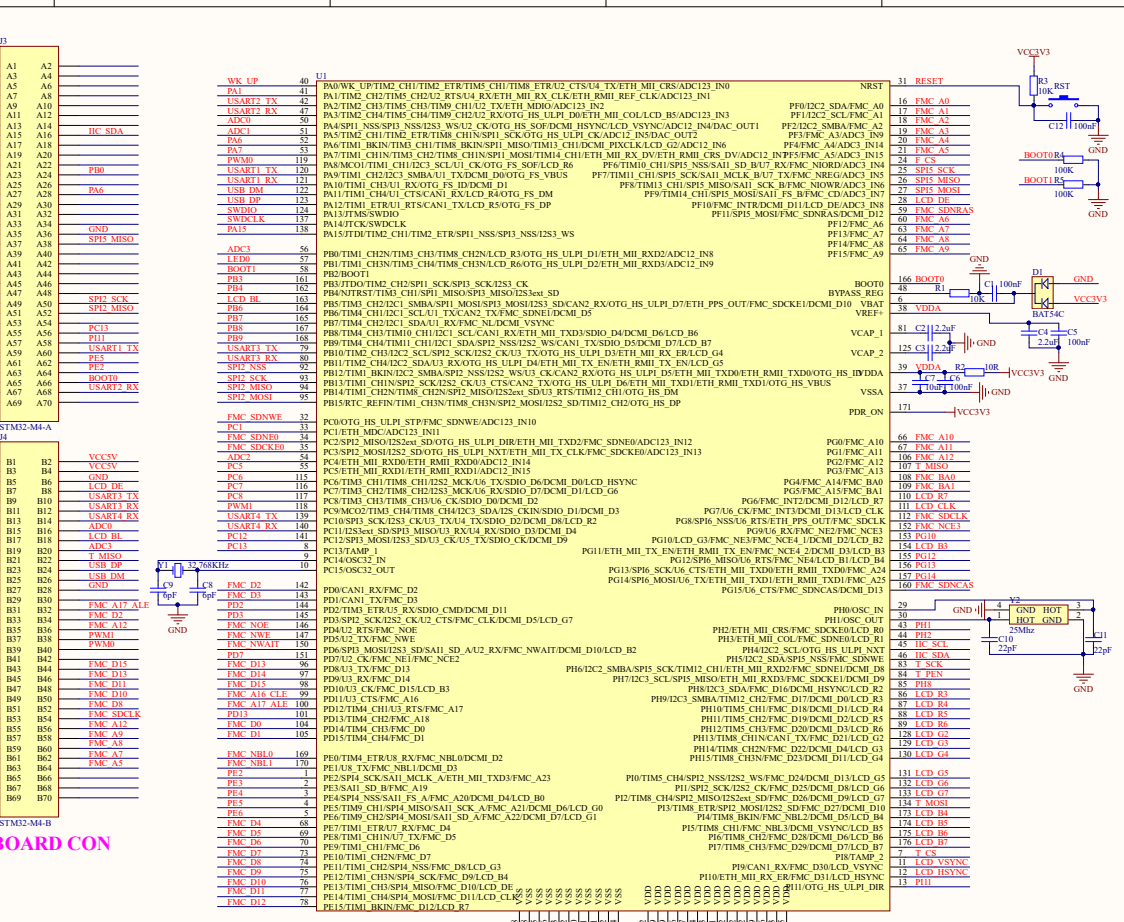

MCU

Table with 4 columns: Size, Number, Revision, and Date. It contains information about the document's version and date.